



Using Avaya E129 SIP Deskphone

Release 1.0
February 2014

Notice

While reasonable efforts have been made to ensure that the information in this document is complete and accurate at the time of printing, Avaya assumes no liability for any errors. Avaya reserves the right to make changes and corrections to the information in this document without the obligation to notify any person or organization of such changes.

Documentation disclaimer

"Documentation" means information published by Avaya in varying mediums which may include product information, operating instructions and performance specifications that Avaya may generally make available to users of its products and Hosted Services. Documentation does not include marketing materials. Avaya shall not be responsible for any modifications, additions, or deletions to the original published version of documentation unless such modifications, additions, or deletions were performed by Avaya. End User agrees to indemnify and hold harmless Avaya, Avaya's agents, servants and employees against all claims, lawsuits, demands and judgments arising out of, or in connection with, subsequent modifications, additions or deletions to this documentation, to the extent made by End User.

Link disclaimer

Avaya is not responsible for the contents or reliability of any linked websites referenced within this site or documentation provided by Avaya. Avaya is not responsible for the accuracy of any information, statement or content provided on these sites and does not necessarily endorse the products, services, or information described or offered within them. Avaya does not guarantee that these links will work all the time and has no control over the availability of the linked pages.

Warranty

Avaya provides a limited warranty on Avaya hardware and software. Refer to your sales agreement to establish the terms of the limited warranty. In addition, Avaya's standard warranty language, as well as information regarding support for this product while under warranty is available to Avaya customers and other parties through the Avaya Support website: <http://support.avaya.com> or such successor site as designated by Avaya. Please note that if you acquired the product(s) from an authorized Avaya Channel Partner outside of the United States and Canada, the warranty is provided to you by said Avaya Channel Partner and not by Avaya.

Licenses

THE SOFTWARE LICENSE TERMS AVAILABLE ON THE AVAYA WEBSITE, [HTTP://SUPPORT.AVAYA.COM/LICENSEINFO](http://support.avaya.com/licenseinfo) OR SUCH SUCCESSOR SITE AS DESIGNATED BY AVAYA, ARE APPLICABLE TO ANYONE WHO DOWNLOADS, USES AND/OR INSTALLS AVAYA SOFTWARE, PURCHASED FROM AVAYA INC., ANY AVAYA AFFILIATE, OR AN AVAYA CHANNEL PARTNER (AS APPLICABLE) UNDER A COMMERCIAL AGREEMENT WITH AVAYA OR AN AVAYA CHANNEL PARTNER. UNLESS OTHERWISE AGREED TO BY AVAYA IN WRITING, AVAYA DOES NOT EXTEND THIS LICENSE IF THE SOFTWARE WAS OBTAINED FROM ANYONE OTHER THAN AVAYA, AN AVAYA AFFILIATE OR AN AVAYA CHANNEL PARTNER; AVAYA RESERVES THE RIGHT TO TAKE LEGAL ACTION AGAINST YOU AND ANYONE ELSE USING OR SELLING THE SOFTWARE WITHOUT A LICENSE. BY INSTALLING, DOWNLOADING OR USING THE SOFTWARE, OR AUTHORIZING OTHERS TO DO SO, YOU, ON BEHALF OF YOURSELF AND THE ENTITY FOR WHOM YOU ARE INSTALLING, DOWNLOADING OR USING THE SOFTWARE (HEREINAFTER REFERRED TO INTERCHANGEABLY AS "YOU" AND "END USER"), AGREE TO THESE TERMS AND CONDITIONS AND CREATE A BINDING CONTRACT BETWEEN YOU AND AVAYA INC. OR THE APPLICABLE AVAYA AFFILIATE ("AVAYA").

Avaya grants you a license within the scope of the license types described below, with the exception of Heritage Nortel Software, for which the scope of the license is detailed below. Where the order documentation does not expressly identify a license type, the applicable license will be a Designated System License. The applicable number of licenses and units of capacity for which the license is granted will be one (1), unless a different number of licenses or units of capacity is specified in the documentation or other materials available to you. "Software" means Avaya's computer programs in object code, provided by Avaya or an Avaya Channel Partner, whether as stand-alone products, pre-installed, or remotely accessed on hardware products, and any upgrades, updates, bug fixes, or modified versions thereto. "Designated Processor" means a single stand-alone computing device. "Server" means a Designated Processor that hosts a software application to be accessed by multiple users. "Instance" means a single copy of the Software executing at a particular time: (i) on one physical machine; or (ii) on one deployed software virtual machine ("VM") or similar deployment.

License types

Basic IPT License.

Copyright

Except where expressly stated otherwise, no use should be made of materials on this site, the Documentation, Software, Hosted Service, or hardware provided by Avaya. All content on this site, the documentation, Hosted Service, and the Product provided by Avaya including the selection, arrangement and design of the content is owned either by Avaya or its licensors and is protected by copyright and other intellectual property laws including the sui generis rights relating to the protection of databases. You may not modify, copy, reproduce, republish, upload, post, transmit or distribute in any way any content, in whole or in part, including any code and software unless expressly authorized by Avaya. Unauthorized reproduction, transmission, dissemination, storage, and or use without the express written consent of Avaya can be a criminal, as well as a civil offense under the applicable law.

Third Party Components

"Third Party Components" mean certain software programs or portions thereof included in the Software or Hosted Service may contain software (including open source software) distributed under third party agreements ("Third Party Components"), which contain terms regarding the rights to use certain portions of the Software ("Third Party Terms"). As required, information regarding distributed Linux OS source code (for those Products that have distributed Linux OS source code) and identifying the copyright holders of the Third Party Components and the Third Party Terms that apply is available in the Documentation or on Avaya's website at: <http://support.avaya.com/Copyright> or such successor site as designated by Avaya. You agree to the Third Party Terms for any such Third Party Components

Preventing Toll Fraud

"Toll Fraud" is the unauthorized use of your telecommunications system by an unauthorized party (for example, a person who is not a corporate employee, agent, subcontractor, or is not working on your company's behalf). Be aware that there can be a risk of Toll Fraud associated with your system and that, if Toll Fraud occurs, it can result in substantial additional charges for your telecommunications services.

Avaya Toll Fraud intervention

If you suspect that you are being victimized by Toll Fraud and you need technical assistance or support, call Technical Service Center Toll Fraud Intervention Hotline at +1-800-643-2353 for the United States and Canada. For additional support telephone numbers, see the Avaya Support website: <http://support.avaya.com> or such successor site as designated by Avaya. Suspected security vulnerabilities with Avaya products should be reported to Avaya by sending mail to: securityalerts@avaya.com.

Trademarks

The trademarks, logos and service marks ("Marks") displayed in this site, the Documentation, Hosted Service(s), and Product(s) provided by Avaya are the registered or unregistered Marks of Avaya, its affiliates, or other third parties. Users are not permitted to use such Marks without prior written consent from Avaya or such third party which may own the Mark. Nothing contained in this site, the Documentation, Hosted Service(s) and Product(s) should be construed as granting, by implication, estoppel, or otherwise, any license or right in and to the Marks without the express written permission of Avaya or the applicable third party.

Avaya is a registered trademark of Avaya Inc.

All non-Avaya trademarks are the property of their respective owners. Linux® is the registered trademark of Linus Torvalds in the U.S. and other countries.

Downloading Documentation

For the most current versions of Documentation, see the Avaya Support website: <http://support.avaya.com>, or such successor site as designated by Avaya.

Contact Avaya Support

See the Avaya Support website: <http://support.avaya.com> for Product or Hosted Service notices and articles, or to report a problem with your Avaya Product or Hosted Service. For a list of support telephone numbers and contact addresses, go to the Avaya Support website: <http://support.avaya.com> (or such successor site as designated by Avaya), scroll to the bottom of the page, and select Contact Avaya Support.

Federal Communications Commission (FCC) Interference Statement

This equipment has been tested and found to comply with the limits for a Class B digital device, pursuant to Part 15 of the FCC rules. These limits are designed to provide reasonable protection against harmful interference in a residential installation. This equipment generates, uses, and can radiate radio frequency energy and, if not installed and used in accordance with the instructions, may cause harmful interference to radio communications. However, there is no guarantee that interference will not occur in a particular installation. If this equipment does cause harmful interference to radio or television reception, which can be determined by turning the equipment off and on, the user is encouraged to try to correct the interference by one of the following measures:

- Reorient or relocate the receiving antenna.
- Increase the separation between the equipment and receiver.
- Connect the equipment into an outlet on a circuit different from that to which the receiver is connected.
- Consult the dealer or an experienced radio/TV technician for help.

This device complies with Part 15 of the FCC Rules. Operation is subject to the following two conditions: (1) This device may not cause harmful interference, and (2) this device must accept any interference received, including interference that may cause undesired operation.

FCC Caution: Any changes or modifications not expressly approved by the party responsible for compliance could void the user's authority to operate this equipment.

FCC/Industry Canada Radiation Exposure Statement

This device complies with the FCC's and Industry Canada's RF radiation exposure limits set forth for the general population (uncontrolled environment) and must not be co-located or operated in conjunction with any other antenna or transmitter.

US/Canada

Hearing Aid Compatibility (HAC) as per FCC Part 68 This equipment complies with the CE Marking requirements.

Canada

This Class B digital apparatus complies with Canadian ICES-003. Cet appareil numérique de la classe B est conforme à la norme NMB-003 du Canada.

Australia Warning

The handset receiver contains magnetic devices that can attract small metallic objects. Care should be taken to avoid personal injury.

EU Countries

This device complies with the essential requirements and other relevant provisions of Directive 1999/5/EC. A copy of the Declaration may be obtained from <http://support.avaya.com> or Avaya Inc., 211 Mt. Airy Road, Basking Ridge, NJ 07920 USA.

Japan VCCI-Class B statement

This is a Class B product based on the standard of the VCCI Council. If this is used near a radio or television receiver in a domestic environment, it may cause radio interference. Install and use the equipment according to the instruction manual.

DenAn Power Cord Regulatory Notice for Japan

 **Warning**

Please be careful of the following while installing the equipment:

- Please only use the Connecting cables, power cord, AC adaptors shipped with the equipment or specified by Avaya to be used with the equipment. If you use any other equipment, it may cause "failures, malfunctioning or fire".
- Power cords shipped with this equipment must not be used with any other equipment. In case the above guidelines are not followed, it may lead to death or severe injury

 **警告**

本製品を安全にご使用頂くため、以下のことにご注意ください。

- 接続ケーブル、電源コード、ACアダプタなどの部品は、必ず製品に同梱されております。添付品または指定品をご使用ください。添付品・指定品以外の部品をご使用になると故障や動作不良、火災の原因となることがあります。
- 同梱されております付属の電源コードを他の機器には使用しないでください。上記注意事項を守らないと、死亡や大怪我など人身事故の原因となることがあります。

Contents

Chapter 1: Introduction	7
Purpose.....	7
Intended audience.....	7
Support.....	7
Related resources.....	7
Documentation.....	7
Chapter 2: Getting started	9
Feature description.....	9
Connection ports.....	10
Deskphone stand.....	10
Attaching the stand.....	11
Detaching the stand.....	11
Button layout.....	12
Icons.....	13
Logging in to the deskphone.....	14
Logging out of the deskphone.....	14
Locking the deskphone.....	14
Unlocking the deskphone.....	15
Chapter 3: Outgoing calls	17
Making a call.....	17
Moving between calls.....	17
Making a call using on-hook dialing.....	18
Making a call when on another call.....	18
Making a call using the phone book.....	18
Making a call using the LDAP directory.....	19
Making a call using the call history.....	19
Redialing the last dialed number.....	20
Making a call using off-hook autodialing.....	20
Making an emergency call.....	21
Chapter 4: Incoming calls	23
Answering a call.....	23
Rejecting a call.....	23
Answering a call when on another call.....	23
Making a blind call transfer.....	24
Making an attended call transfer.....	24
Chapter 5: Call Forward	27
Activating Call Forward.....	27
Deactivating Call Forward.....	27
Chapter 6: Conference calls	29
Starting a conference.....	29
Starting a conference by joining two calls.....	29
Putting a conference on hold.....	30
Resuming a conference on hold.....	30
Splitting a conference.....	30

Ending a conference.....	31
Chapter 7: Call-related features.....	33
Muting a call.....	33
Unmuting a call.....	33
Putting a call on hold.....	34
Resuming a call on hold.....	34
Chapter 8: Call history.....	35
Viewing the call history.....	35
Deleting an entry from the call history.....	35
Deleting all entries of a specific call type.....	36
Deleting all entries from the call history.....	36
Chapter 9: Voice mail.....	37
Retrieving a voice mail.....	37
Chapter 10: Contacts.....	39
Adding a contact.....	39
Contact field descriptions.....	40
Adding a contact from the LDAP directory.....	40
Adding a contact from the call history.....	41
Editing contact details.....	41
Searching a contact.....	42
Deleting a contact.....	42
Deleting all contacts.....	43
Adding a group.....	43
Editing a group.....	43
Deleting a group.....	44
Chapter 11: Deskphone customization.....	45
Enabling Do Not Disturb.....	45
Disabling Do Not Disturb.....	45
Setting a ring tone.....	46
Setting the ring tone volume.....	46
Setting the screen contrast.....	46
Setting a display language.....	47
Setting the date and time.....	47
Chapter 12: Deskphone diagnostics.....	49
Performing audio check.....	49
Checking deskphone keys.....	49
Checking deskphone dial pad.....	50
Index.....	51

Chapter 1: Introduction

Purpose

This document describes how to use AvayaE129 SIP Deskphone features in Avaya Aura[®] Communication Manager and IP Office environments.

Intended audience

This document is intended for people who want to learn how to use product features and capabilities.

Support

Visit the Avaya Support website at <http://support.avaya.com> for the most up-to-date documentation, product notices, and knowledge articles. You can also search for release notes, downloads, and resolutions to issues. Use the online service request system to create a service request. Chat with live agents to get answers to questions, or request an agent to connect you to a support team if an issue requires additional expertise.

Related resources

Documentation

Document number	Title	Use this document to:	Audience
Using			

Document number	Title	Use this document to:	Audience
16-604369	Administering Avaya E129 SIP Deskphone	Administer configurations and settings for Avaya E129 SIP Deskphone.	Users and administrators
16-604373	Avaya E129 SIP Deskphone Quick Reference	See frequently used tasks.	Users and administrators
Implementing			
16-604370	Installing and Maintaining Avaya E129 SIP Deskphone	See the installation and upgrade procedures for Avaya E129 SIP Deskphone.	Administrators and network engineers

Chapter 2: Getting started

Feature description

Avaya E129 SIP Deskphone is a SIP-based IP phone that small-to-medium businesses can use for communication.

Physical specifications

- Two call appearances
- A 128 x 40 graphical LCD
- Three softkeys
- Dual network ports with integrated Power over Ethernet (PoE)
- Electronic Hook Switch (EHS) with a Plantronics headset

Feature specifications

- Call forwarding
- Call transferring
- Three-way conferencing
- Voice mail
- Deskphone customization
- Do not Disturb

Connection ports

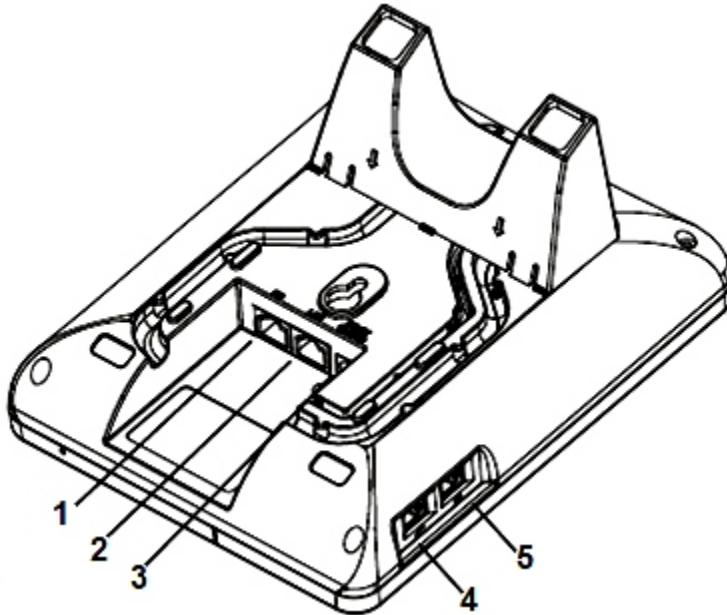

Figure 1: Connection ports at the back of the deskphone

Number	Port name	Description
1	PC	A 10/100-Mbps RJ45 port to connect to a personal computer or a mobile computer
2	LAN	A 10/100-Mbps RJ45 port to connect to PoE-supported Ethernet
3	Power	A 5-V DC port to connect to the power supply
4	Handset	An RJ9 port to connect the handset
5	Headset	An EHS-supported RJ9 port to connect to a Plantronics headset

Deskphone stand

You can either wall mount your deskphone or attach the stand that Avaya provides.

The stand includes four hooks that fit into four slots in the rear of the deskphone.

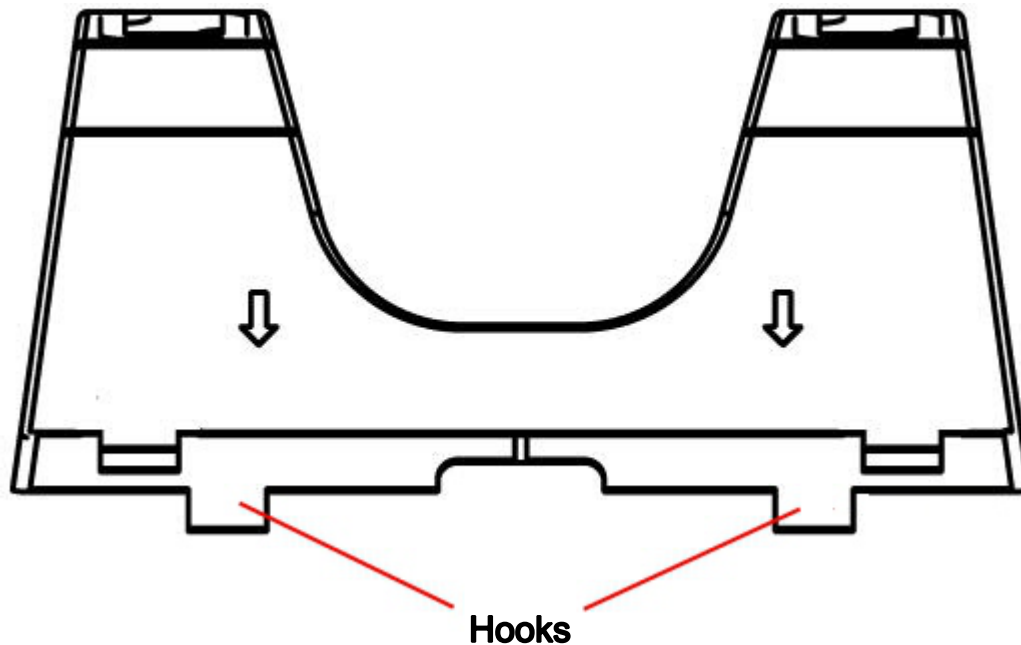

Attaching the stand

Procedure

1. Hold the stand with the arrows facing down and towards the side of the LAN and PC ports.
2. Insert the hooks on the side that does not have arrow marks into the upper two slots.
3. On the arrow-marked side, press the hooks and push down into the lower two slots.
The stand fits into the back of the deskphone.

Detaching the stand

Procedure

On the arrow-marked side, press the hooks, and pull up from the lower two slots. The hooks in the upper two slots detach simultaneously.









Button layout



Number	Button name	Description
1	Softkeys	Display screen-specific commands.
2	Phonebook	Displays the contacts list.
3	Transfer	Transfers the call to the selected number.
4	Mute	Mutes and unmutes the microphone.
5	Speaker	Activates and deactivates the speakerphone.
6	Volume	Increases and decreases the volume.
7	Call	Dials the number that you enter.
8	Flash	Puts the current call on hold and brings up the second line for dialing or answering the second call.

Number	Button name	Description
9	Conference	Starts the conference.
10	Message	Dials the voice mail server.
11	Up, Down, Right, and Left navigation keys	Navigates between various menu options. You can use the Left navigation key to perform the back function that takes you one level up the menu options.
12	Menu	Displays the menu or selects the highlighted option.
13	Message Waiting Indicator	Turns red if you get a voice mail.

Icons

Icon	Name	Description
	Not registered	The deskphone is not registered to the SIP server.
	Registered	The deskphone is registered to the SIP server.
	Handset	The handset is off-hook.
	Speaker	The speaker is enabled.
	Headset	The headset is enabled.
	Do not disturb	The Do Not Disturb feature is enabled.
	Call forward	The Call Forward feature is enabled.
	Mute	The deskphone is on mute.
	SRTP	The deskphone is using Secure Real-time Transport Protocol (SRTP).

Logging in to the deskphone

Procedure

1. In the **Username** field, enter the extension number.
2. Press the **OK** softkey.
3. In the **Password** field, enter the password.
4. Press the **OK** softkey.

Result

The deskphone logs in and displays the idle screen.

Logging out of the deskphone

About this task

The deskphone does not forward calls in the logged out state even if you enabled the call forwarding feature. Instead, you can lock the deskphone. The deskphone continues to forward calls in the locked state.

Procedure

1. Press  **Menu > LogOut**.
2. Press the **OK** softkey when the deskphone prompts for confirmation.

Locking the deskphone

Before you begin

Ensure that the administrator enabled the feature for your deskphone.

About this task

Lock the deskphone if you are moving away from your desk and do not want anyone to use the deskphone in your absence. The emergency dialing feature is unavailable if the deskphone is locked.

Procedure

Press the star (*) key for 4 seconds.

Result

The deskphone displays the message `Keypad is locked`.

Unlocking the deskphone



Procedure

1. Press the star (*) key for four seconds.
The deskphone displays the **Password** field.
2. Enter the password to unlock the deskphone.

Chapter 3: Outgoing calls

Making a call

Procedure



1. Perform one of the following actions:
 - Lift the handset.
 - Press  **Speaker**.
 - Press the **Headset** softkey.
 2. Enter the phone number.
 3. Press  **Call**.
-

Moving between calls

Before you begin



You must be on two calls simultaneously.

Procedure

1. Press  **Flash**.
Your deskphone puts the current call on hold and resumes the other call.
 2. To return to the previous call, press  **Flash** again.
-

Making a call using on-hook dialing

Procedure



1. Enter the phone number.
 2. Perform one of the following actions:
 - Lift the handset.
 - Press  **Speaker**.
 - Press the **Headset** softkey.
 - Press  **Call**.
-

Making a call when on another call

About this task

Use the following procedure to make another call when you are already on an active call. You can make only two calls simultaneously.

Procedure

1. Press  **Flash**.
 2. Enter the phone number.
 3. Press  **Call**.
-



Making a call using the phone book

Before you begin

You must have at least one entry in the phone book.

Procedure

1. Perform one of the following actions:

- To select a contact from the phone book, press  **Phonebook** > **Local Phonebook**.
 - To select a contact from a group, press  **Phonebook** > **Local Group**, and then select the required group.
2. Select the required contact.
 3. Press  **Call**.
-

Making a call using the LDAP directory

About this task

Use the following procedure to make a call to contact listed in the LDAP directory. Do not change the LDAP configurations as only your administrator can configure the LDAP settings.

Procedure

1. Press  **Menu** > **LDAP Directory** > **Search**.
 2. Enter the string or the number that you want to search.
 3. Press the **OK** softkey.
The deskphone displays all matching contacts.
 4. Scroll and select the required contact.
 5. Press the **Edit and Dial** softkey.
 6. Edit the number if required, else press the **OK** softkey.
-

Making a call using the call history

Procedure



1. Press  **Menu** > **Call History**.
2. Select from the following call types:
 - **Answered Calls**
 - **Dialed Calls**
 - **Missed Calls**

- **Transferred Calls**

3. Select the required number.
 4. Press  **Call**.
-

Redialing the last dialed number

Procedure

1. Perform one of the following actions:
 - Lift the handset.
 - Press  **Speaker**.
 - Press the **Headset** softkey.
 2. Press  **Call**.
-

Result

The deskphone dials the last dialed number.

Making a call using off-hook autodialing

Before you begin

Ensure that your administrator configured an autodial number for your deskphone.

About this task

Use the following procedure when you want the deskphone to call a preconfigured autodial number as soon as you lift the handset. You can make a frequently dialed number the autodial number. To call other numbers, use on-hook dialing.

Procedure

- Perform one of the following actions:
- Lift the handset.
 - Press  **Speaker**.
 - Press the **Headset** softkey.
-

Result

The deskphone dials the number that your administrator configured as the autodial number.

Making an emergency call



Before you begin

You must obtain the emergency number from your administrator.

About this task

Use the following procedure to dial an emergency number. The emergency dialing feature is unavailable if the deskphone is locked or in an unregistered state.

Procedure

1. Perform one of the following actions:
 - Lift the handset.
 - Press  **Speaker**.
 - Press the **Headset** softkey.
 2. Enter the emergency number.
 3. Press  **Call**.
-

Outgoing calls

Chapter 4: Incoming calls

Answering a call

Procedure

Perform one of the following actions:

- Lift the handset.
 - Press  **Speaker**.
 - Press the **Headset** softkey.
 - Press the **Answer** softkey
-

Rejecting a call

Procedure

Press the **Reject** softkey when you get an incoming call.

If the administrator configured call redirection, the deskphone redirects the call to the redirection number. Otherwise, the deskphone drops the incoming call.

Answering a call when on another call

About this task

If you get another call while you are on a call, the deskphone plays a call waiting tone and displays the call on the phone screen.

Procedure

Perform one of the following actions:

- Press  **Flash**.
- Press the **Answer** softkey.

Result

The deskphone puts the first call on hold and moves to the second call.

Making a blind call transfer



Before you begin

You must answer the call before transferring the call to another deskphone.

About this task

A blind transfer is when you transfer an active call to another deskphone without announcing the call transfer. The deskphone to which you transfer the call displays your phone number instead of the transferred call phone number.

Procedure

1. Press  **Transfer**.
2. Perform one of the following tasks:
 - Enter the number to which you want to transfer the call.
 - Select the number from the phone book.
3. Press  **Call**.
4. To complete the transfer, put back the handset.

Result

Your deskphone transfers the call to the selected number.

Making an attended call transfer



Before you begin

- Ensure that the administrator enabled the Auto- Attended Transfer feature for your deskphone.
- Answer the call before transferring the call.

About this task

An attended transfer is when you transfer an active call to another phone number after announcing the call transfer.

Procedure

1. While on a first call, press  **Transfer**.
2. Enter the number to which you want to transfer the call.
3. Press  **Call**.
The second deskphone starts ringing. You can stop the ringing and end the transfer by pressing the **Split** softkey.
4. Tell the contact about the call when the contact answers your call.
You can cancel the transfer by pressing the **Split** softkey. In this case, the deskphone separates the two calls and puts the first call on hold and the second call in an active state.
5. Press  **Transfer**.

Result

Your deskphone transfers the active call to the selected number and disconnects.

Incoming calls

Chapter 5: Call Forward

Use the Call Forward feature to divert incoming calls to another number. The Avaya E129 SIP Deskphone supports the following Call Forward types:

Call Forward type	Description
Forward All	Forwards all incoming calls to another number.
Forward Busy	Forwards incoming calls to another number if you are on a call.
Forward No Answer	Forwards incoming calls that you do not answer within a stipulated time to another number. The default time is 20 seconds.

Activating Call Forward

About this task

Use the following procedure to activate Call Forward through the Call Features option.

Procedure



1. Press **Menu** > **Call Features**.
 2. Select the account, and press **Menu**.
 3. Select the required Call Forward type, and press **Menu**.
 4. Enter the number to which you want to forward the call.
 5. Press the **Enable** softkey.
-

Deactivating Call Forward

About this task

Use the following procedure to deactivate Call Forward through the Call Features option.

Procedure

1. Press  **Menu** > **Call Features**.
 2. Select the account, and press  **Menu**.
 3. Select the required Call Forward type, and press  **Menu**.
 4. Press the **Disable** softkey.
-



Chapter 6: Conference calls

Starting a conference

About this task

Use the following procedure to start a conference. This conference is a local conference that the E129 deskphone manages. If one of the participants puts the call on hold and music-on-hold is configured for that participant, then the other two participants hear the music. The other participants can also converse with each other.

Procedure

1. Make the first call.
 2. Press  **Conference**.
 3. Make the second call.
 4. Press  **Conference** or the **ConfCall** softkey.
The deskphone starts the conference between you and the calls that you made.
-

Starting a conference by joining two calls

Before you begin

You must have two active calls.

Procedure

1. Press  **Conference**.
 2. Press  **Flash**.
-

Result

The deskphone starts the conference between you and the two active calls.

Putting a conference on hold

Before you begin

You must have an active conference.

Procedure

Press the **Hold** softkey.
The deskphone puts the participants on hold.

Resuming a conference on hold

Before you begin

You must have a conference on hold.

Procedure

Press the **ReConf** softkey.

Splitting a conference

About this task

Use the following procedure to split a conference into separate calls. When you split a conference, the conference ends, and you can continue the conversation with the participants on separate lines.

Procedure

1. Press the **Hold** softkey.
The deskphone puts the participants on hold.
 2. Press  **Flash**.
-

Result

The deskphone resumes the second call.

Ending a conference

Before you begin

You must have an active conference.

Procedure

Press the **EndCall** softkey.

The deskphone ends the conference and disconnects the participants.

Chapter 7: Call-related features

Some of the call-related features that you can use are:

- Muting a call
- Putting a call on hold
- Blocking the caller ID
- Enabling call waiting for a call

Muting a call

About this task

Use the following procedure to mute your deskphone during an active call so that the contacted person cannot hear you. If you receive a call after muting the deskphone for the first call, the deskphone unmutes if you answer the second call. If you change to the first call, the deskphone remains muted.

Procedure

Press  **Mute**.

Unmuting a call

Before you begin

You must have a call on mute.

About this task

Use the following procedure to unmute your deskphone so that the contacted person can hear you.

Procedure

Press  **Mute**.

Putting a call on hold

About this task

Use the following procedure to put an active call on hold. The deskphone stops displaying the call timer when you put a call on hold.

Procedure

Press the **Hold** softkey.

Resuming a call on hold

Before you begin

You must have a call on hold.

Procedure

Press the **Resume** softkey.

Chapter 8: Call history

Viewing the call history

Procedure

1. Press **Menu** > **Call History**.
 2. Select one of the following call types:
 - **Answered Calls**
 - **Dialed Calls**
 - **Missed Calls**
 - **Transferred Calls**
 3. Press **Menu**.
 4. Select the entry for which you want to view the details, and press **Menu**.
-

Deleting an entry from the call history

Procedure

1. Press **Menu** > **Call History**.
2. Select one of the following call types:
 - **Answered Calls**
 - **Dialed Calls**
 - **Missed Calls**
 - **Transferred Calls**
3. Press **Menu**.
4. Select the entry that you want to delete, and press **Menu**.
5. Scroll and select **Delete**.

6. Press **Menu**.
 7. Press the **Delete** softkey to confirm the deletion.
-

Deleting all entries of a specific call type

About this task

Use the following procedure to delete all entries of a specific call type. The deskphone displays the **Delete All Entries** option only if you have at least one entry.

Procedure

1. Press **Menu > Call History**.
 2. Select one of the following call types:
 - **Answered Calls**
 - **Dialed Calls**
 - **Missed Calls**
 - **Transferred Calls**
 3. Press **Menu**.
 4. Scroll and select **Delete All Entries**.
 5. Press **Menu**.
 6. Press the **Delete** softkey to confirm the deletion.
-

Deleting all entries from the call history

Procedure

1. Press **Menu > Call History**.
 2. Scroll and select **Clear All**.
 3. Press **Menu**.
 4. Press the **Delete** softkey to confirm the deletion.
-

Chapter 9: Voice mail

Retrieving a voice mail

Before you begin

Your administrator must have configured your voice mail user ID.

About this task

Message Waiting Indicator (MWI) blinks red to indicate that you have a voice mail.

Procedure

1. Perform one of the following actions:
 - Press  **Message**.
 - Dial the number of the voice mail server.
 2. Follow the voice prompts to listen to your messages.
-

Voice mail

Chapter 10: Contacts

Avaya E129 SIP Deskphone provides the facility to save contacts locally on the deskphone. You can also assign contacts to groups.

You can manage contacts through:

- A contact XML file. Only an administrator can manage contacts through the XML file.
- The deskphone interface

You can save 500 contacts on the deskphone and create 10 groups that include the 3 default groups that the deskphone provides.

Adding a contact



About this task

Use the following procedure to add a contact to the deskphone. You can save 500 contacts on the deskphone.

The deskphone displays the Phone screen without saving any contact data if :

- You are adding a contact while you are on a call and the call disconnects while you are still entering the contact information.
- You answer a call while you are still entering the contact information.

Procedure

1. Press  **Phonebook** > **Local Phonebook** > **New Entry**.
2. Enter contact details.
3. Scroll and select **Confirm Add**.
4. Press  **Menu**.

Related topics:

[Contact field descriptions](#) on page 40

Contact field descriptions

Name	Description
First Name	The first name of the contact. You can enter up to 24 characters.
Last Name	The last name of the contact. You can enter up to 24 characters.
Number	The phone number of the contact.
Groups	The group, if any, to which the contact belongs. Select one or more of the following options: <ul style="list-style-type: none">• Family• Friends• Work





Adding a contact from the LDAP directory

Procedure

1. Press  **Menu** > **LDAP Directory** > **Search**.
 2. Enter the string or the number that you want to search.
 3. Press the **OK** softkey.
The deskphone displays all matching contacts.
 4. Scroll and select the required contact.
 5. Scroll and press the **Save to Phonebook** softkey.
The deskphone displays the contact details.
 6. Scroll and press the **Confirm Add** softkey.
-

Adding a contact from the call history

Procedure



1. Press  **Menu** > **Call History**.
2. Select one of the following call types:
 - **Answered Calls**
 - **Dialed Calls**
 - **Missed Calls**
 - **Transferred Calls**
3. Press  **Menu**.
4. Select the entry that you want to add, and press  **Menu**.
5. Scroll and select **Save to Phonebook**.
The deskphone does not display the full name of the contact.
6. Enter contact details.
7. Scroll and select **Confirm Add**.
8. Press  **Menu**.

Related topics:

[Contact field descriptions](#) on page 40

Editing contact details

Procedure



1. Press  **Phonebook** > **Local Phonebook**.
 2. Select the contact whose details you want to edit, and press  **Menu**.
 3. Update the contact details.
 4. Scroll and select **Save**.
 5. Press  **Menu**.
-

Related topics:

[Contact field descriptions](#) on page 40



Searching a contact

Procedure

1. Press  **Phonebook** > **Local Phonebook**.
 2. Press the **Search** softkey.
 3. Enter the number, the name, or a part of the contact name.
 4. Press the **OK** softkey.
The deskphone displays all matching contacts.
 5. Scroll and select the required contact.
 6. Perform one of the following actions:
 - To edit the contact details, press  **Menu**.
 - To dial the contact, press  **Call**.
-

Deleting a contact

Procedure

1. Press  **Phonebook** > **Local Phonebook**.
 2. Select the contact that you want to delete, and press  **Menu**.
 3. Scroll and select **Delete**.
 4. Press  **Menu**.
 5. Press the **Delete** softkey to confirm the deletion.
-

Deleting all contacts

Procedure

1. Press  **Phonebook** > **Local Phonebook**.
 2. Press the **More** softkey, and then press the **DeleteAll** softkey.
 3. Press the **Delete** softkey to confirm the deletion.
-

Adding a group

About this task

Use the following procedure if you want to add more groups to the default list on your deskphone. You can create 10 groups on the deskphone that includes the default groups that the deskphone provides.

Procedure

1. Press  **Phonebook** > **Local Group** > **New Group**.
 2. Enter a name for the group.
 3. Press the **OK** softkey.
The deskphone adds the group and displays it in the group list.
-



Editing a group

About this task

Use the following procedure to edit a group that you created. You cannot edit default groups.

Procedure

1. Press  **Phonebook** > **Local Group**.



2. Select the group that you want to edit, and press  **Menu**.
 3. Select **Edit Group**, and press  **Menu**.
 4. Edit the group name.
 5. Press the **OK** softkey.
-

Deleting a group

About this task

Use the following procedure to delete a group that you created. You cannot delete default groups.

Procedure

1. Press  **Phonebook > Local Group**.
 2. Select the group that you want to delete, and press  **Menu**.
 3. Select **Delete Group**, and press  **Menu**.
-

Chapter 11: Deskphone customization

Some of the features that you can customize for your deskphone are:

- Ring tone
- Ring tone volume
- Display screen contrast
- Date and time
- Display language

Enabling Do Not Disturb

About this task

If you enable the Do Not Disturb feature, the deskphone diverts all incoming calls to your voice mail. If the administrator did not configure your voice mail, the caller hears a busy tone.

Procedure

Press  **Menu > Preference > Do Not Disturb > Enable DND.**
The deskphone displays the Do Not Disturb icon on the screen.

Disabling Do Not Disturb

Before you begin

Ensure that the Do Not Disturb feature is activated.

About this task

When you deactivate the Do Not Disturb feature, the deskphone accepts all incoming calls and provides a ringing alert.

Procedure

Press  **Menu > Preference > Do Not Disturb > Disable DND.**

The deskphone does not display the Do Not Disturb icon on the screen.

Setting a ring tone

About this task

Use the following procedure to set a ring tone for the deskphone.

Procedure

1. Press **Menu** > **Preference** > **Ring Tone**.
 2. Select the required ring tone, and press **Menu**.
-

Setting the ring tone volume

Procedure

1. Press **Menu** > **Preference** > **Ring Volume**.
 2. Use the **Right** or **Left** navigation keys to select the desired volume.
 3. Press the **OK** softkey.
-

Setting the screen contrast

Procedure

1. Press **Menu** > **Preference** > **LCD Contrast**.
 2. Use the **Right** or **Left** navigation keys to select the contrast level.
 3. Press the **OK** softkey.
-

Setting a display language

Procedure

1. Press **Menu** > **Preference** > **Display Language**.
 2. Select the required language, and press **Menu**.
-

Setting the date and time

Procedure

1. Press **Menu** > **Preference** > **Time Settings**.
 2. Enter the date and time.
 3. Press the **OK** softkey.
-

Chapter 12: Deskphone diagnostics

The Avaya E129 SIP Deskphone provides the option to check the audio and the dial pad of the deskphone.

Performing audio check

About this task

Use the following procedure to check whether the audio of the deskphone is functional.

Procedure

1. Press **Menu** > **Factory Functions** > **Audio Loopback**.
 2. Speak to test the deskphone.
If the audio is functional, you can hear your own voice.
 3. To end the audio check, press **Menu**.
-

Checking deskphone keys

About this task

Use the following procedure to check that the deskphone keys and the LED are functional.

Procedure

1. Press **Menu** > **Factory Functions** > **Diagnostic Mode**.
The MWI LED starts to glow red.
 2. Press the key that you want to check.
The deskphone displays the name of the key on the screen. If the name does not match the key that you pressed, it implies that there is some problem with the key. If you pressed **Call**, the MWI LED turns green.
 3. To end the key check, press **Menu**.
-

Checking deskphone dial pad

About this task

Use the following procedure to check whether the deskphone dial pad is functional. You must press all keys to end the dial pad check.

Procedure

1. Press **Menu > Factory Functions > Keyboard Diagnostic**.
The deskphone displays names of all keys on the screen.
 2. Press a key.
The deskphone removes the name of the key that you pressed.
 3. Repeat Step 2 for all the keys on the dial pad.
The deskphone ends the check when you finish pressing all the keys on the dial pad.
-

Index

A

activating	27
Call Forward	27
add	41 , 43
group	43
contact from call history	41
answer call	23
attended transfer	24
audio check	49
auto-attended transfer feature	24
autodial	20
off-hook	20

B

blind transfer	24
buttons	12
description	12
name	12

C

call	23 , 24 , 33 , 34
answer	23
attended transfer	24
blind transfer	24
mute	33
put on hold	34
reject	23
resume	34
unmute	33
call features	33
Call Forward	27
activating through Call Features	27
deactivating through Call Features	27
types	27
call history	35 , 36
delete all entries	36
delete an entry	35
deleting all entries of specific call type	36
view	35
call muting	33
call unmuting	33
calling	17 – 21
emergency number	21

from call history	19
from the LDAP directory	19
last dialed number	20
off-hook autodialing	20
on-hook dialing	18
using phone book	18
while on another call	18
check deskphone dial pad	50
check deskphone keys	49
conference	29 – 31
end	31
on hold	30
resume	30
split	30
start	29
with two active calls	29
connection ports	10
contact	39 – 43
add	39
add from the call history	41
add from the LDAP directory	40
adding a contact	40
delete	42
field descriptions	40
LDAP directory	40
search	42
contacts	39
customizable features	45

D

deactivating	27
Call Forward	27
delete	35 , 36
all call history entries	36
all entries of specific call type	36
call history entry	35
delete all	43
delete all contacts	43
deskphone diagnostics	49
deskphone keys check	49
deskphone stand	10 , 11
attaching	11
detaching	11
dial pad check	49 , 50
disable	45

Do Not Disturb	45
Do Not Disturb	45
disable	45
enable	45
document purpose	7

E

E129	9
feature specifications	9
overview	9
physical specifications	9
E129 features	9
E129 specifications	9
edit	41
emergency call	21
enable	45
Do Not Disturb	45

G

group	43 , 44
add	43
delete	44
edit	43

I

icons	13
incoming call	23
answering while on another call	23
answering	23
rejecting	23

K

keypad layout	12
---------------------	--------------------

L

LDAP directory	19
----------------------	--------------------

legal notices	2
locking the deskphone	14
logging in to the deskphone	14
logging out of the deskphone	14

M

making a call	19
moving between calls	17
muting	33

R

redialing	20
reject call	23
related documentation	7
resume conference	30
ring tone	46

S

setting	29 , 46 , 47
display language	47
ring tone	46
ring tone volume	46
screen contrast	46
time	47
splitting conference	30
stand	10
starting conference between active calls	29
support	7
contact	7

T

transfer	24
attended	24
blind	24

U

unlocking the deskphone	15
unmuting	33

V

voice mail	37
retrieving	37